



DIGITAL INDUSTRIES SOFTWARE

NX Design add-on modules

Extending product development features and capabilities

Benefits

- Extend features and capabilities of NX Design software
- Configure with process-, industry- and application-specific tools
- Provides flexible token-based licensing

Summary

The NX™ Design software products are preconfigured, tiered solutions (NX Design Standard, NX Design Advanced and NX Design Premium) targeted at specific product development disciplines and problems. You can extend and enhance the functionality of NX solutions with add-on modules. Configure your solutions to specific requirements with specialized design tools, standard parts applications, design-integrated simulation solutions, programming and customization toolkits and direct translators. NX software, Simcenter™ 3D software, Teamcenter® software, the Fibersim™ portfolio and the Mastertrim™ portfolio are part of the Siemens Xcelerator business platform of software, hardware and services. The token-licensed add-ons, which are marked with an asterisk (*), in the product's overview are part of the value-based licensing pool. Token licensing provides you with extra flexibility, as you can use the tokens to activate any product that is part of the token pool.

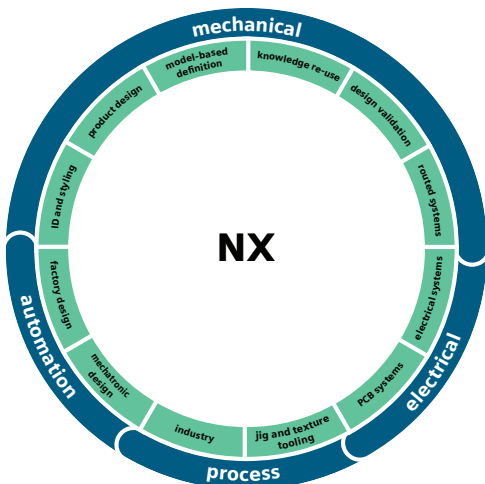

Core applications

NX includes various core functionalities that enable you to exchange data between proprietary systems and NX, check designs in full size with virtual reality (VR) tools and give you an extra boost in usability with artificial intelligence (AI)-powered command prediction.

NX Translator for STEP AP 242*

Achieve bidirectional translation using the STEP AP242 translation protocol.

NX Translator for CATIA V4*

Achieve bidirectional translation between CATIA V4 and NX. Access files from the file open, file save as, file import and file export dialogs. This tool flattens assemblies to a single level for import and export.

NX Translator for CATIA V5*

Use this module for bidirectional translation and to read CATPart and CATProduct files. This tool reads coordinate systems, points and part substructure, geometry, assembly structure and attributes of color, layer and name into NX.

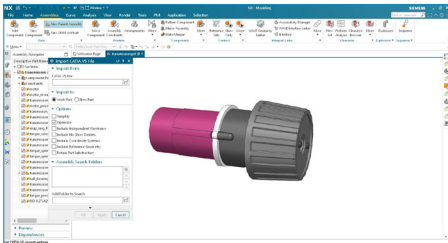

NX Translator for Creo*

Read Creo Parametric solids and surfaces from .prt and .asm files and create an NX part or assembly.

NX Translator for ACIS*

Translate two-way data exchange between NX and computer-aided design (CAD) models in the ACIS modeling kernel format.

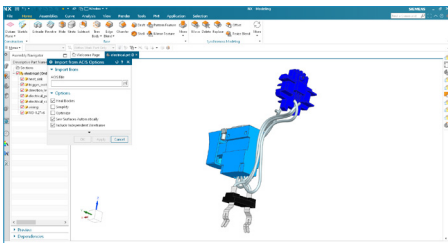

NX Translator for IFC*

Achieve bidirectional translation using the Industry Foundation Classes (IFC) file format, which describes architectural, building and construction data.

NX Translator for Rhino*

Open and import Rhino .3dm files into NX.

NX Translator for 3DXML*

Open and import .3Dxml files into NX.

NX Translator for Revit*

Open and import Autodesk Revit .RVT files into NX.

NX Translator for G3D*

Open and import GOM .G3D files containing a tessellated mesh into NX as a Convergent Body.

NX Command Prediction*

The machine learning (ML) or AI-enabled user interface (UI) can predict and provide commands to the user based on learned command use patterns. It allows you to personalize the design environment by considering the differences in knowledge, style and preferences. Leveraging and sharing learned command use data reduces the learning curve, promotes using domain- and/or industry-specific best practices and increases productivity.

NX Smart Selection

This module uses predictive data analytics to predict entities that designers will likely select for a given command.

NX Select Similar Faces*

NX Select Similar Faces software performs operations on geometrically similar regions with fewer clicks.

NX Voice – Command Assistant*

Realize productivity gains with easy-to-use speech-to-text commands that transform multiple levels of menus and clicks.

NX Viewer*

Open, view and measure NX models and drawings in the native NX format. This is ideal for when you have access to and need to view NX data but do not intend to save or reauthor NX data.

NX DMU and Markup*

Access a digital mockup (DMU) and markup functions, including Create DMU Workset, Create Snapshot, Manipulate Snapshot, Insert Product, Move in Workset, Reset to Design State and Add Markups.

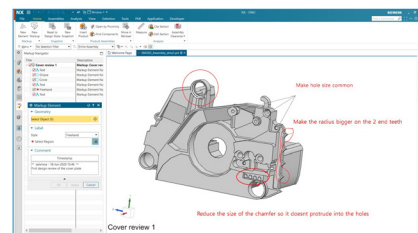

*Token licensing available

NX DMU and Markup Add-on for NX Viewer*

Perform digital mockup functions in NX Viewer.

NX Extended Reality*

Publish 3D product designs to a range of augmented, virtual and mixed reality (MR) workflows and share your ideas easily with colleagues or customers. You can use the NX Extended Reality output across a range of augmented reality (AR) and VR experiences, which a variety of browsers natively support.

NX Appearance Management*

Set up a series of visual appearances quickly and easily on a single master model. When combined with NX Render, you can create a high-quality render of these visual appearances for design reviews or marketing assets.

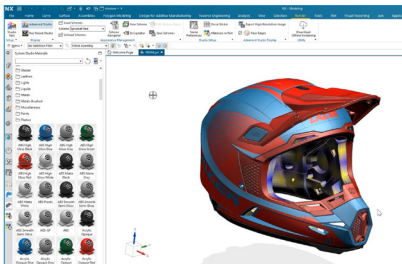

NX Appearance Management for Managed User*

Define an appearance product scheme to manage a product's appearance variability when managing design data with Teamcenter.

NX Multi-User Design Notification*

Use NX Multi-User Design Notification to leverage a collaborative design environment. This module enables proactive notifications of changes in your design context.

NX Smart Context Designer*

With NX Smart Context Designer software, an NX managed user can create, open and save a product workset containing one or more filtered product assemblies and view the product data via a partition scheme. Additionally, using Smart Discovery enables you to search, filter and retrieve information.

NX Immersive Explorer*

Immerse yourself in various environments using the NX Immersive Explorer software and a desktop mode or a VR headset. With design review tools in this immersive environment, such as Drawing Notes, Measure, Assembly Navigator, Sticky Notes, Snapshot and Section, engineers, managers, stakeholders and end-users can review and gain valuable insights on their designs.



NX Immersive Designer*

Interact with and manipulate 3D digital models as if they were physical objects in an immersive space. This module requires using the Sony XR head-mounted display for visuals and controllers. With the Sony XR-head mounted display and NX Immersive Designer, you can design products in high fidelity with NX capabilities in the real world via an immersive experience. Reach out and touch your designs at scale, leverage multiple virtual monitors while working simultaneously with a traditional keyboard and mouse, directly edit virtual models without exiting your immersive environment and interact with designs using hand controllers.

NX Copilot*

Ask natural language questions, access detailed technical insights and streamline complex design tasks to design faster and smarter with less errors and rework.



Mechanical

Industrial design and styling

Create aesthetically appealing, innovative products with fast concept design, freeform shape modeling and surfacing capabilities, including subdivision modeling, Class-A surfacing and reverse engineering. Additionally, use enhanced visualization with dynamic and real-time photorealistic rendering tools to create visually stunning models.

NX Render*

Create photorealistic images for design reviews, marketing assets and sales collateral by leveraging best-in-class rendering technology. Creating the perfect-looking image is easy with the addition of an all-new set of render-ready materials. Simply drag-and-drop materials, lighting and cameras into your scene in minutes to achieve desired results with accurate texture and reflection.



*Token licensing available

NX Realize Shape*

Use subdivision modeling methods to create advanced 3D product shapes with unprecedented speed and ease of use. The toolset is equally suited for creating quick 3D concepts or high-quality final surface shapes. Since NX Realize Shape™ software is fully inte-

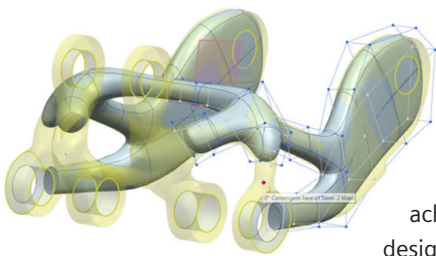

grated with all NX modeling functions, it seamlessly incorporates traditional modeling approaches, which allows you to achieve a high degree of design refinement.

NX Draw Shape*

Freehand draw wireframe shapes on bodies, enabling you to visually convey and communicate aspects of the design prior to investing in 3D models.

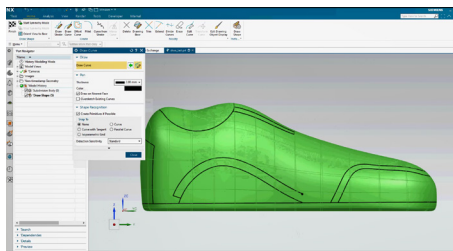

Product design

The core modeling capability of NX combines wireframe, surface, solid, parametric and direct modeling in a single environment. This enables designers to choose the most appropriate tool for the task at hand. By leveraging capabilities such as synchronous technology and Convergent Modeling™ technology, it is easy to edit designs with simple push-pull methods and work with facet or mesh data in the same modeling environment. The adaptive UI of NX uses ML to help improve productivity.

NX Show/Hide Similar

With this ML-enabled functionality, you can show or hide multiple components that are geometrically similar to a selected component. You can use this functionality to easily declutter assemblies or perform operations on geometrically similar components.

NX Layout

NX Layout includes dedicated tools to support 2D data migration, 2D design and layout, as well as 2D to 3D capabilities to explore concepts in 2D and iterate and transfer to 3D for generating 3D models and assemblies.

NX WAVE Control*

Define interpart relationships for parametric assembly modeling using NX WAVE™ Control feature functionality, which is a geometry linking tool. With NX WAVE assembly control structures and constraints, you can simplify design changes and accelerate the modeling of configurations, options and variants.



NX Assembly Path Planning*

NX Assembly Path Planning software automatically determines the optimal, interference-free path for extracting a component from an assembly. It stores the resulting path as a set of steps within an assembly sequence. You can use the extraction path to streamline serviceability studies by verifying component access without requiring a physical prototype or extensive analysis.

NX Lattice Structures Design

Often used in additive manufacturing, lattice structures help reduce weight without compromising structural integrity. With NX Lattice Structure Design, you can use a set of design capabilities, including custom lattice cells, to suit specific design needs. For example, improving strength, rigidity, impact resistance, energy absorption or porosity and custom and randomized lattice structures. It is also possible to filter for individual lattice rods and create special tetrahedron surface and volume lattice structures.



NX Structure Designer*

Create structural frames more efficiently by leveraging the easy-to-use structural frame modeling capability in the NX Structure Designer software. Additionally, you can generate structural frames in minutes using the frame drawing assistant, which can create 2D skeletons with minimal clicks.

NX Platform Design*

Design equipment support structures, accessways, walkways, maintenance platforms and similar steel structures with these specialized tools to maximize productivity for modeling platforms, plating of platforms, reinforcements, corner conditions, handrails, stairs and ladders.

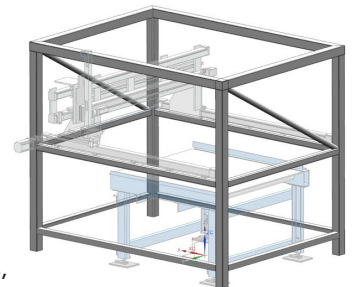

*Token licensing available

NX Topology Optimizer*

Automate improving structural designs while meeting various performance, material and manufacturing requirements with NX Topology Optimizer. It contains powerful optimization capabilities, including the ability to set up and optimize a single component or system assembly. Additionally, you can add various design and manufacturing constraints to control the optimization results, such as design symmetry, offset, shelling, blending, additive overhang angles, additive self-supporting, additive material spreading, molding, casting, machining and extrusion.

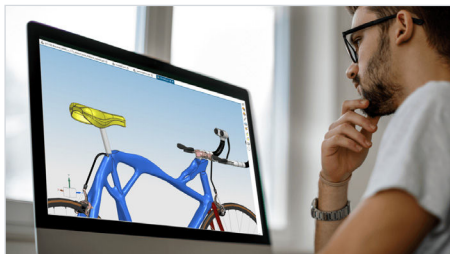

NX Design Space Explorer*

NX Design Space Explorer includes multiple objective design space exploration and optimization capabilities.

NX Performance Predictor*

With NX Performance Predictor software, perform quick simulations to review their product’s design performance regarding simulation results. This allows them to evaluate design change impacts in the NX design environment earlier.

NX Advanced Sheet Metal*

Model complex sheet metal parts that contain drawn features and nonlinear bend lines. With the advanced flange function, you can easily create nonlinear flanges using customer input parameters or existing geometry to define shapes and specify end limits. The completely revised joggle function enables you to add complex joggles to flanges or tabs, including single and multiple jogs. The flat pattern feature provides rich data for down-stream consumption.

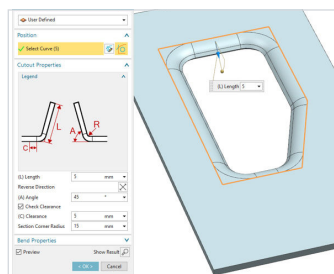

NX Fabric Flattener*

Generate flat patterns for woven or unidirectional fabric materials. Additionally, flatten composite laminate plies or any material that conforms to the theoretical models for woven or unidirectional fabrics.

NX Weld Assistant*

Create welds, structural adhesives and mechanical connection features. This includes resistance spot welds, mechanical clinches, arc welds in the shape of fillets, butts, J bevels, V bevels and flared bevels. Additionally, you can generate sealer beads with any cross-sectional shape and defined spray-on adhesive, mastic or glue. There are also validation checks for all discrete weld types, along with import and export capabilities. An automatic annotation function generates standard weld symbols and product manufacturing information, and you can publish all weld features to Teamcenter when using managed mode.

NX Physical Architecture Diagram Author*

You can use this module for model-based systems engineering (MBSE) and for managing and tracing large numbers of product and technical requirements throughout the design process. It can show connections such as WAVE links, assembly constraints and dimensions between components of a 3D assembly and show the current validation status of associated NX Requirements. This package can be used standalone in NX or in conjunction with Teamcenter Parameter Management.

NX Physical Parameter Management Author*

Use this add-on for MBSE and for managing and tracing large numbers of product and technical requirements throughout the design process. It manages mechanical requirements and reports on measured results for master 3D and computer-aided engineering (CAE) models. This can be used as a standalone feature in NX or in conjunction with Teamcenter Parameter Management.

NX Physical Architecture Diagram Viewer*

View connections such as WAVE links, assembly constraints and dimensions between 3D assembly components and report on the status of requirement checks on measurement.

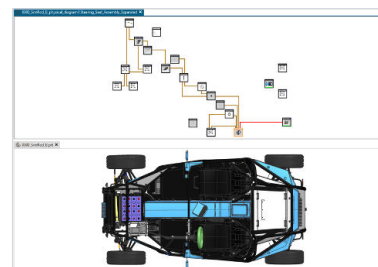

*Token licensing available

NX Physical Parameter Management Viewer*

View reports on measurements in the CAD model and the status of checks on values from the CAE results performed in other applications.

NX Reference Point Cloud View

Visualize point cloud files in the point database (POD) format. Additionally, easily add referenced point cloud objects into layout models (for example, from NX Line Designer and ship design applications) and perform various operations on the point clouds, including measurements and clipping. This helps improve virtual planning workflows and reduce the number of errors during physical implementation.

NX Join*

Reduce the time spent placing and defining fasteners and hardware while improving fastener assembly design quality using NX Join software. You can define standard join features with information and attributes about the connection between assembly components. This module covers the basic definition of point-based connections, including rivets, bolts, adhesives and spot welds.

NX OmniFree Transformer

Morph surfaces into points or curves in the NX environment. The points, or curves, compensate for the springback that occurs during stamping.

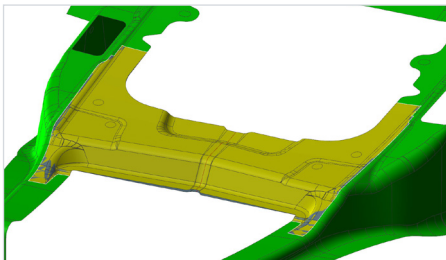

NX OmniMesh Transformer

Morph tools using capabilities that let you morph surfaces into CAE meshes, STL data or point clouds in the NX environment. The mesh, STL or point cloud compensates for springback that occurs during stamping.

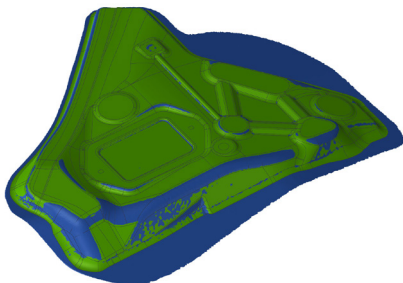

NX Advanced Convergent Modeling™*

Seamlessly work with mesh geometry in an integrated CAD workflow. Using this add-on, it becomes much easier to work with data from 3D scanners, polygon modelers, simulation software and topology optimization. Additionally, it makes it easier to prepare mesh (STL) geometry for 3D printing.

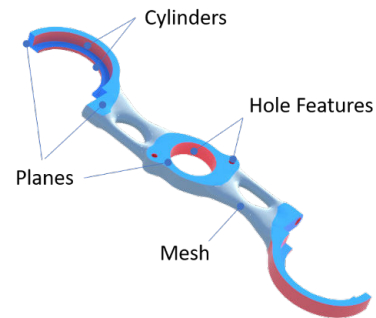

NX Implicit Modeling*

Create equation-driven structures and perform robust modeling operations on complex designs. Additionally, design advanced geometric shapes with relative ease and complex operations between geometry that have a high degree of robustness over more traditional methods like boundary representation (B-rep) modeling. Using features of Convergent Modeling and NX, you can present these results in a usable format for downstream modeling and simulation/manufacturing operations.



NX Advanced Assemblies*

Simplify components or subassemblies into a single, lightweight solid, enclose assembly geometry in an envelope of planar faces, partition assemblies into meaningful regions and manage the weight and other mass properties of components and assemblies. With component filtering techniques, quickly identify and load relevant components, avoiding unnecessary delays and screen clutter from loading irrelevant components.

*Token licensing available

NX Design for Additive Manufacturing*

This add-on includes capabilities that aid you in designing parts that are suitable for production using additive manufacturing or 3D printing.

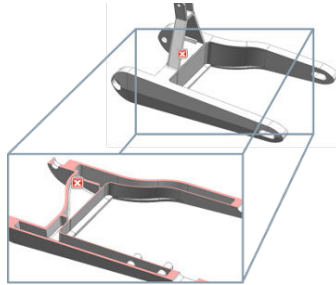

NX Composites*

NX Composites software includes the capability to develop end-to-end composite parts directly in NX with integrated model interrogation and design for manufacturing tools.

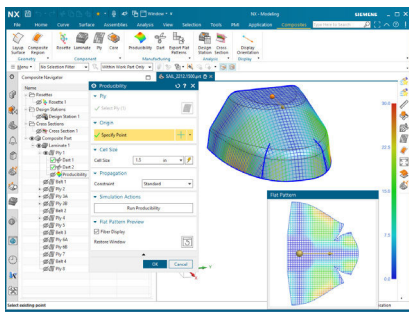

NX Composites Laser Projection Interface*

Generate laser projection controller data for layup assistance in manufacturing composite parts.

NX Composites CAE Interface*

Send as-manufactured composite ply data to CAE for structural analysis of composite parts.

NX Sustainability Impact Analysis*

Perform sustainability calculations and rollups at any product design phase with the NX Sustainability Impact Analysis software. Additionally, conduct what-if analyses and ML-driven optimizations.



NX Lattice Designer*

Using NX Lattice Designer software, create various types of performance-optimized lattice structures as convergent geometry for lightweighting, energy absorption, thermal management, osseointegration, etc.

NX Author for ECLASS*

Document a design part to the ECLASS classification standard, improving communication along the value chain. Requires prerequisites of Teamcenter Classification for ECLASS and Classification User.

Model-based definition

Model-based definition capabilities in NX enable the production of a complete digital definition of a product within a 3D model. By establishing the model as the single source of truth, NX reduces the time spent on engineering documentation, drives downstream tools for validation and manufacturing, and reduces late changes and scrap.

NX Product and Manufacturing Information*

Product and manufacturing information is nongeometric data applied to a 3D model to convey information about the design of a product's components for manufacturing. This contributes to MBD by conveying information such as geometric dimension and tolerance (GD&T), 3D annotation, surface finish and material specifications.

With the NX Product and Manufacturing Information solution, you can produce a complete digital definition of a product within a 3D model, eliminating the need for traditional drawings.

NX Model Based Definition*

NX Model Based Definition software is an add-on to the NX Product and Manufacturing Information application. This add-on includes advanced capabilities that support MBD deployments, including automatically authoring product and manufacturing information (PMI) and user-defined rules. This functionality incorporates an interactive Logic Editor diagramming interface that supports building and executing rules for authoring PMI. With NX Model Based Definition rules, topological feature recognition with associative updating enables you to work with full featured models or featureless data.

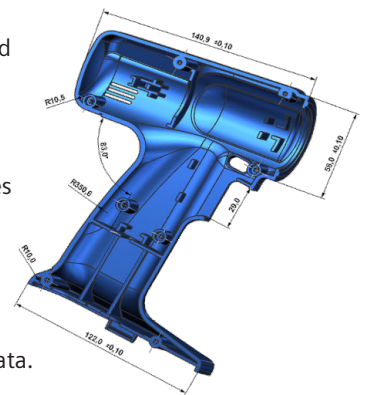

*Token licensing available

NX PMI Effectivity*

Determine which PMI on a model is relevant for each product configuration when you are designing products that contain many variations. Additionally, infer the effectivity of PMI objects based on the referenced geometry. This displays only PMI objects that are relevant to the selected product configuration.

NX Technical Data Package

A technical data package can contain important technical data such as models, drawings, associated lists, specifications, standards and performance requirements. NX Technical Data Package includes the functionality to create, modify, save, store and reuse technical data package templates and publish technical data packages in industry-recognized formats, including JT plus PDF and 3D PDF.

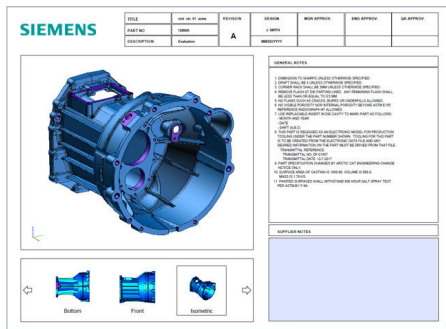

NX Coatings*

Define paint and coating information in the CAD model, including coating material, face and boundary location and thickness with the NX Coatings software. Afterwards, you can define the coating, include it in the mass properties calculation, annotate it using PMI or drawing notes and include it in the parts list rollout or bill-of-materials (BOM).

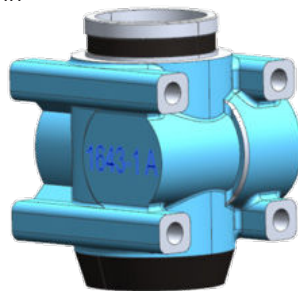

NX Inspector

Characterize PMI for integration into PLM and quality processes. This allows consumption of design and engineering data in quality and manufacturing. NX Inspector supports the Digital Metrology Standards Consortium (DMSC) Model-Based Characteristic standard. You must have the NX Product and Manufacturing Information add-on module to use NX Inspector.

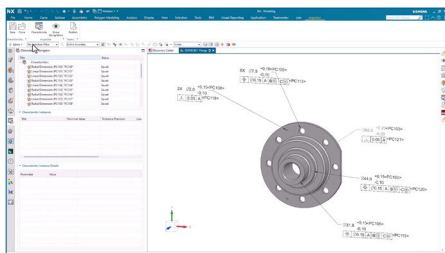

Knowledge reuse

With the knowledge reuse capabilities in NX, you can shorten design cycles, reduce development costs and improve productivity. Additionally, by leveraging knowledge-driven automation capabilities, your company can capture, reuse and consistently apply best practices across product lines.

NX Algorithmic Modeling*

Create algorithmically driven designs as well as design and automate advanced variational, parametric shapes that are not possible with traditional interactive CAD modeling. This module uses a novel, logic editor-based approach to build an algorithm that defines the shape and variability of a design, provides an easy-to-use interface and creates automation and design templates.

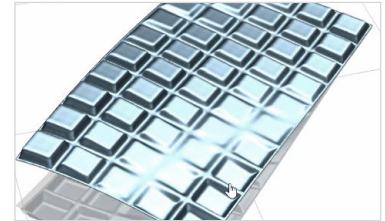

NX Product Template Studio Author*

You can use templates to modularize a design, breaking a complex assembly into manageable modules, which you can recombine as needed to configure complex products. With NX Product Template Studio Author, you can add a user-defined interface to any parametric model, which you can intuitively describe and package parametric models for later reuse.

NX Product Template Studio Consumer*

Display and interact with user-defined template interfaces created in the Product Template Studio Author application. This consumer license also enables the template model UI to be automatically invoked as you leverage template models from the NX Reuse Library.

NX Open Toolkits Author

NX Open Toolkits Author is a collection of application programming interfaces (APIs) for developing custom applications in NX using an open architecture with well-known programming languages (C, C++, Visual Basic, C#, Java and Python). Using custom programs can automate complex and repetitive tasks, integrate third-party applications and customize the NX UI.

NX Open for .NET Author

The NX Open for .NET Author license includes access to the NX .NET API libraries, documentation and utility tools to create .NET custom applications.

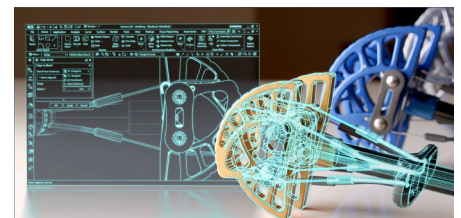

*Token licensing available

NX Open Python Author

The NX Open Python Author license includes access to the NX Python API libraries, documentation and utility tools to create Python-based custom applications.

NX Open Dialog Designers

Access the application modules, visual dialog builder, libraries and documentation necessary to interactively construct production-quality dialogs for use in the NX environment and supported platforms. The dialog designer consists of two design tools: the Block Styler, which provides interactive tools to design block-based dialogs, and the User Interface Styler, which provides various widgets to construct a dialog for use in the NX environment.

NX Open GRIP Author

Graphics interactive programming (GRIP) is a programming language for automated operations in NX. In some cases, you can use GRIP to perform advanced, customized operations in a more efficient manner than using NX interactively. Additionally, leverage the GRIP Advanced Development Environment (GRADE) for editing, compiling and linking GRIP programs.

NX Integration to Geolus*

Dynamically search and retrieve parts that have been indexed into the Geolus® software database, which is part of the Siemens Xcelerator business platform. The shape search can look for exact or similar matches and open the part into the NX session.

NX Integration Classification*

Reuse your company's content and data by browsing the classification hierarchy or searching classification content based on attribute-value for a specific classification node or class definition. Requires prerequisites of Teamcenter Smart Discovery, Context Management User and Partitions.

Design validation

NX includes powerful visual product analytics and validation tools that you can use to quickly synthesize information, check designs for compliance with requirements and make informed decisions. Integrated design for manufacturing checks significantly reduces engineering change orders (ECOs), manufacturing defects, costs and delays. With design-integrated motion, structural and thermal simulation tools in NX, you can quickly compare design alternatives and optimize performance characteristics early in the design process.

NX Human Modeling*

Create feature models of human beings, which can be used to explore and verify how people interact with product designs. Additionally, use the human models to explore and verify how people interact with product designs within the NX environment.

NX Human Modeling Posture Prediction*

NX Human Modeling Posture Prediction is specifically aimed at the automotive industry, and with it, you can position a model of a human driver, front passenger or rear passenger in a statistically accurate seated position inside an automobile. Specify the position of the hands and feet, such as the driver's hands and feet touching the steering wheel and brake pedal, and the model then predicts an occupant's hip location, eye location and arm and leg position based on the type of vehicle and the occupant's hand and foot locations.

NX Design Simulation*

Validate the structural performance of your design, compare design alternatives and optimize the performance characteristics of products early in the design process with design-integrated simulation. This simulation technology is based on and scalable to Simcenter 3D for further analysis by expert analysts. The result is a highly iterative and predictive engineering process that delivers innovative designs, higher-quality products and reduces time-to-market.

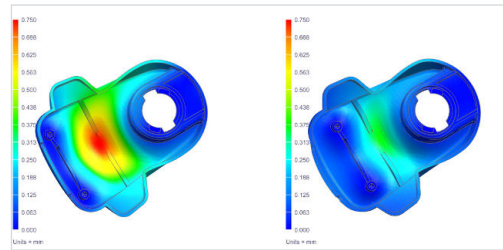

NX Motion*

Predict and understand the functional, dynamic mechanical behavior of assemblies and mechanisms. NX Motion is an advanced yet easy-to-use solution for understanding, evaluating and optimizing the complex motion behavior of assemblies and products. Based on Simcenter 3D simulation technology, NX Motion is a complete solution for kinematics and dynamic motion analysis of rigid multibody and static equilibrium. Additionally, you can easily transfer data to Simcenter 3D for more detailed analyses. Using performance simulation early is key to evaluating design options to increase design confidence and reduce risk.

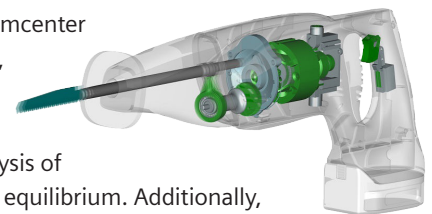

*Token licensing available

NX Animation Designer*

Model the kinematic behavior of any product with moving parts in a time-based manner to gain a better understanding of how the product will operate and determine clearances between parts during movement. Additionally, create disassembly animations for visually appealing product presentations.

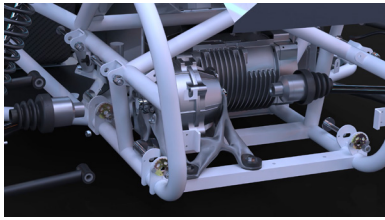

Simcenter FLOEFD for NX

Use Simcenter FLOEFD™ for NX software, which is a full-featured 3D computational fluid dynamics (CFD) analysis solution, to work directly on CAD models to prepare and evaluate CFD simulations for fluid flow and heat transfer.

NX EasyFill Analysis

Analyze part and mold designs during the early design stages with this integrated mold flow simulation tool. This analysis is done via pioneering 3D technology and high-performance 3D filling simulation.

NX EasyFill Analysis – Advanced

To validate mold designs prior to manufacturing, this add-on includes capabilities such as multiple gate analysis, packing, shrinkage and fiber orientation. Additionally, you can perform simulation preprocessing and postprocessing inside the NX CAD environment.

NX Check-Mate Runtime*

Validate the integrity of an NX CAD part file with over 300 out-of-the-box (OOTB) checkers to evaluate part file content, geometry quality, model documentation and adherence to standards. This solution is fully customizable to meet individual customers’ needs and integrated with Teamcenter to link checked results into release workflows.

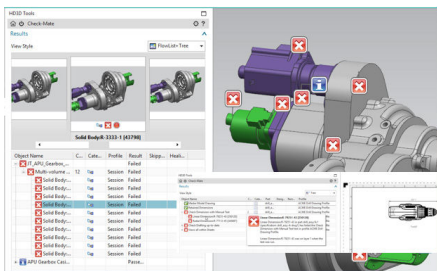

NX Check-Mate Author*

Proactively improve product quality with this automated and customizable tool. Ensure that your CAD data meets expectations by leveraging the customization capabilities that deliver reliable model and part checking.

NX VDA 4955 Checker*

The Association of German Automobile Industry (VDA) add-on software checks the quality of curves, faces, solids and drawing data in an NX part file. It verifies that curves and surfaces adhere to international standards and local country regulations.

NX HD3D Visual Reporting*

You can use NX HD3D Visual Reporting software to display information of interest from your company’s data sources directly into the 3D product design environment. Make unambiguous assessments, interpret information more accurately and synthesize product and process data rapidly to make correct design decisions. NX HD3D Visual Reporting comes with a set of predefined, OOTB reports that design teams can use to answer commonly asked questions. Reports related to ownership, check-out, part maturity, projects, load status, validation status and more are available for instant use. With the authoring capability, create and modify custom reports to extract and present the data.

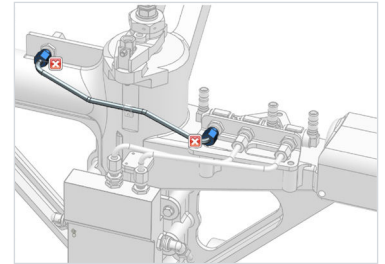

NX One-Step Formability Analysis*

Conduct a quick and accurate finite element modeling (FEM) sheet metal forming analysis and leverage tools for creating flattened blanks and preforms from complex freeform geometry.

NX Mold Cooling*

NX Mold Cooling software includes wizard-based capabilities you can leverage to rapidly simulate the thermal performance of injection mold inserts, identify hotspots and uneven temperatures on the parts, generate reports and compare performance between design iterations. You can perform 1D duct flow simulation and 3D CFD simulation.

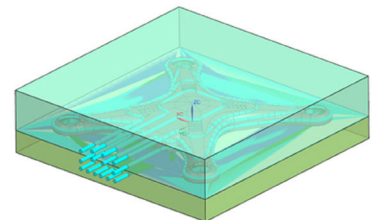

NX Forming

NX Forming software includes state-of-the-art capabilities for sheet metal forming analysis and the forming process steps, including gravity, binder wrap, crash forming, drawing, trimming, flanging and springback.

NX Forming SMP

Solve larger forming analyses quickly by enabling parallel processing. With its distributed memory architecture, you can use NX Forming SMP software for high-performance computing (HPC) by taking full advantage of the multiple central processing units (CPUs), cores and thread configurations of the latest computing platforms in the Windows environment.

*Token licensing available

NX Corrosion Analysis

Predict corrosion analysis of component parts in an assembly based on the proximity and galvanic properties of assigned materials and coatings. Then, view the results in graphical and textual reports.

NX DFM Advisor*

Execute design for manufacturability (DFM) checkers to identify costly and problematic manufacturing areas on your design model. Customize your checker parameters to meet specific design standards.

NX CFD Designer*

Perform flow and thermal simulations within the design environment to streamline the design process and make decisions quicker. You can simulate with internal and external steady-state fluid analyses; laminar, turbulent and transitional flows; liquids and gases; conjugate heat transfer and porous media. View analysis results in NX or open the model in Simcenter FLOEFD for more advanced simulation.

Routed systems

NX digital product development solutions include an integrated suite of tools that can be used to facilitate the entire design process for routed systems, including wire harnesses, cables, piping, tubing, conduit and raceways. Using these process-specific tools reduces detailed design time, improves product quality and transfers product information seamlessly between the logical design, physical design, analysis, manufacturing and service domains.

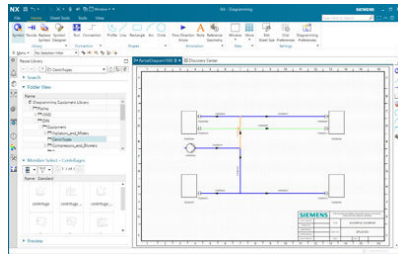

NX Diagramming*

NX Diagramming software is a multidisciplinary diagram creation solution for various industries with an environment for positioning and connecting equipment from standard or custom equipment libraries into logical 2D diagrams via superior diagram creation tools. It includes a specific task environment to easily create new symbol libraries and runs and branches in the diagram that can then connect with real 3D equipment.

NX Routing Base*

NX Routing Base incorporates the core capabilities all NX-routed system design solutions use. This includes the general capabilities you need to create, edit, copy and move paths. Additionally, there are tools for defining standard part libraries, selecting parts from libraries and intelligently placing standard parts within the paths. Also, define standard stock specifications and assign them to paths.

NX Routing Piping and Tubing*

Optimize piping and tubing design workflows using intelligent path creation, specification-driven part selection, smart part placement, collision detection, weight calculations and knowledge rules that concurrently validate designs against company and industry standards. These tools support rigid and flexible pipes and tubes.

NX Routing HVAC*

Create, modify, validate and document heating, ventilation and air conditioning (HVAC) systems. Additionally, optimize HVAC design workflows using intelligent path creation, specification-driven part selection, smart part placement, collision detection, weight calculations, duct splits, duct size calculation and knowledge rules that concurrently validate designs against company and industry standards. This application includes predefined catalogs of HVAC parts and parametric templates that you can modify quickly (smart sizing) to fit any space constraints. Together with other NX capabilities, like hangers and sheet metal flat patterns, you can leverage a complete lifecycle solution for HVAC design.

NX Piping Fabrication Drawings and PMI

With this add-on to NX Routing, create 3D PMI information and corresponding piping isometric drawings from piping models. The solution captures the necessary information for downstream fabrication in the form of dimensions and annotations from the 3D model. Also, create custom parts lists for the fabrication drawings and update existing PMI views with dimensions, annotations and tables based on changes to the 3D model.



NX Penetration Management*

Create, manage and respond to penetration requests between various user groups responsible for steel structures and routed system design. The process begins with a routed system designer (such as a piping designer) who requests pipe penetrations with structures that another design group designs and maintains, such as a structure group. A penetration request defines the location of the required cutout and initiates a workflow that the end-user can customize to meet specific needs. A typical workflow includes several review steps that you must complete before creating a cutout to satisfy and close the request.

*Token licensing available

Electrical

Electrical systems

NX includes advanced software tools you can use for developing complete electrical systems, from electrical or electronic architecture definition to detailed electrical design and wire harness manufacturing to documentation and diagnostics.

NX Routing Cabling*

Route electrical cables in a product assembly along with typical mechanical parts and supporting equipment, such as conduit and raceways. The software can automatically find paths routed between devices and assign the cable descriptions to the path segments. It can also automatically add cable lengths and diameters to the connection list for feedback to upstream electrical CAD (ECAD) applications or downstream manufacturing applications.

NX Cable Router*

NX Cable Router is an interactive interface to the NX Cable Routing functionality, which cable routing engineers can use to route and visualize a high volume of cables using interactive or automatic routing methods. This includes the ability to search cables based on multiple criteria, visualize start and end devices and set rules and preferences. Additionally, optimize cable routing for large vessels and accelerate cable route visualization, reducing cost and time and guiding designers to the right decisions.

NX Routing Harness*

Route an electrical wiring harness consisting of bundles of wires and specify typical mechanical parts and supporting equipment, such as connectors and other devices. Also, import the wiring characteristics for connections between electrical devices. Physical wire lengths and diameters can be automatically added to the connection list for feedback to upstream ECAD applications or downstream manufacturing applications.

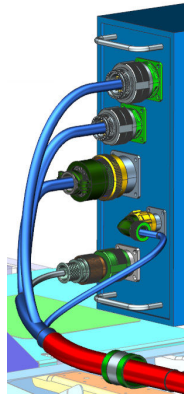

PCB systems

You can use NX for designing both flexible and rigid printed circuit boards (PCBs). Based on workflows common to designing PCBs, the PCB design tools help model printed circuits rapidly and accurately for assembly and send the outlines to manufacturing or an ECAD system for further refinement.

NX PCB Exchange

Intuitively and efficiently design rigid and flexible printed circuits. Additionally, connect directly to all major PCB design applications, supporting various PCB data interchange formats (IDF, ProSTEP EDMD Schema, IDX) and manufacturing formats (ODB++, GenCAD).

NX PCB Exchange for Xpedition

Leverage NX PCB Exchange for Xpedition™ software, which is part of the Siemens Xcelerator business platform, to add a layer of capability to the foundation product. This provides a unique and innovative integration into the Xpedition Enterprise PCB design flow, going beyond industry standard communication methods and making it easy to model and manage 3D ECAD data. You can model boards and components using standard part modeling practices with NX or import them directly from Xpedition. Additionally, create an assembly of the board and components with NX Assembly Modeling and share it with Xpedition.

NX PCB Exchange for Zuken

Transmit information between NX and Zuken CR-5000 and CR-8000 PCB design software. Transmit data, such as the board outline, hole placements, component placements and keep-in and keep-out regions, back and forth using a format native to the Zuken product. Using this software also enables enhanced data exchange concerning board layers, copper trace geometry and bend region geometry.

NX Flexible Printed Circuit Design*

Model printed circuits rapidly and accurately in the context of an assembly and send the outlines to manufacturing or to an ECAD system for further refinement. Additionally, check the printed circuit model developed in NX for clearances and tolerances and transfer the finished board model to an ECAD system for component placement and circuit trace or layer development.

Process-based applications

Jigs, fixtures and tooling

Automate the entire tool development process, including part design, tool assembly layout, detailed tooling design and validation using advanced NX functionality. With step-by-step guidance and associativity to part designs, you can work with even the most challenging tooling and fixture designs.

NX Mold Wizard*

Create designs quickly and efficiently with this working environment of supporting functions and component data for mold designs. Employ a process thread approach to identify and develop the critical functions necessary to complete mold design tasks. This approach includes implementing tools that simplify, automate and guide you through the tasks involved in designing plastic injection molds.

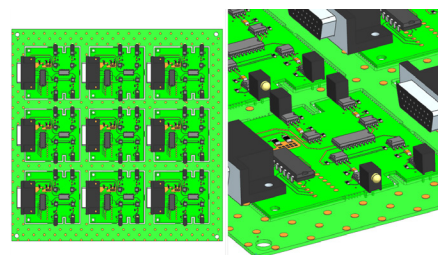

NX Molded Part Designer*

NX Molded Part Designer software includes molded part validation and simulation tools for product designers to get their product design closer to the finished product without going through costly iterative and prototyping processes.

NX Feature2Cost – Stamping

Analyze a product design and identify key features, such as bends, embossing and sheet metal thickness, that influence stamping tool manufacturing. Once you analyze and identify the features, you can transfer the information to Teamcenter Tool Costing software to estimate manufacturing costs.

NX Feature2Cost – Mold

Analyze the product design and identify key features such as ribs, openings, cores or cavities, side cores and others that influence injection mold manufacturing. Once you analyze the features, you can transfer the information to Teamcenter Tool Costing to estimate the cost to manufacture the injection molding tools.

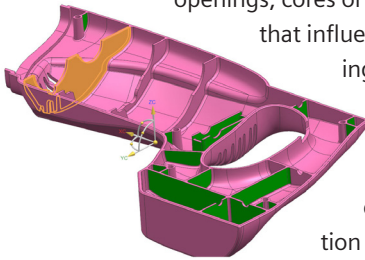

NX Flow Blend

Create robust constant or variable blends along multiple complex faces with small curvatures that are essential for manufacturing.

NX Electrode Design*

Streamline the design and production of electrodes for electrical discharge machining (EDM). Automate and effectively design, validate, document, manufacture and manage the entire electrode development process from design to production.

NX Progressive Die Wizard*

Construct progressive stamping dies. When planning the forming process, define preprocesses, unfold the part, perform formability analysis (using NX One-Step Formability Analysis), nest the flat pattern (blank layout), design the scrap and determine the strip and tool layout.

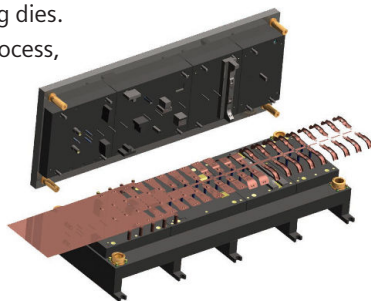

NX Die Structure Design*

Create blank, draw, trim and flange dies and associated transfer equipment for stamping sheet metal parts.

NX Die Engineering*

Leverage process-specific tools for die face design in a wizard environment.

NX Molded Part Validation*

Analyze parts and automatically get information about draft angles, undercut areas, sharp corners, small radiuses and other items that could compromise molding quality. Also, visually check the core and cavity sides easily.

NX Conformal Cooling Channel Design*

Automate creating the conformal cooling channel on 3D-printed metal mold inserts, such as a core and cavity. This eliminates many manual modeling processes that improve the creation of conformal cooling channels for mold inserts.



NX Tooling Locators*

Using NX Tooling Locators software provides the ability to generate and manage datum locators and measurement points typically used in creating an assembled structure. Assign connected parts to aid in coordinating and configuring datums to automatically determine the control direction. A variety of measurement point types are supported, including surface, trim, hemmed edge, hole, slot and stud.

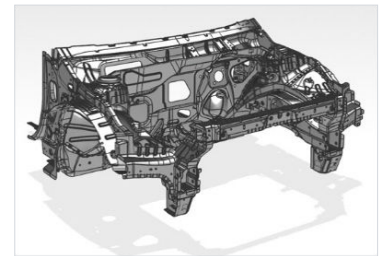

Industry-specific applications

NX includes workflow solutions built for the specific needs of individual industries, with modules for aerospace design, vehicle design automation (VDA), ship structure design, human modeling and automation engineering of production systems.

NX General Packaging*

This VDA software, General Packaging, is a set of software assistants and advisors that you can use to automate a wide range of tasks associated with a vehicle's mechanical, safety, vision and occupant packaging. The vehicle design automation functionality checks designs for compliance with international standards and local country regulations.

NX Vehicle Design and Validation

Define the position of vision devices like mirrors and cameras in vehicles such as cars, trucks and heavy equipment machinery in accordance with national and international safety standards. It works in conjunction with NX General Packaging.

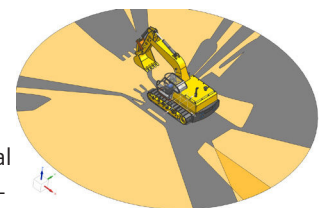

*Token licensing available

NX Vehicle Design Advanced Validation

NX Vehicle Design Advanced Validation is a combination bundle incorporating NX General Packaging and NX Vehicle Design and Validation.

Fibersim*

Fibersim includes special-purpose tools for engineering and manufacturing parts from fiber-reinforced composite materials. Support a concurrent engineering process by performing design and analysis for manufacturing processes in a 3D environment.

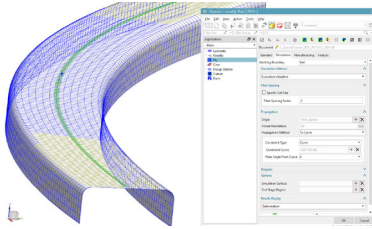

Mastertrim*

Engineer transportation seating and interiors that efficiently define, communicate and maintain a complete and single representation of the automotive seat and interior components across disciplines. Once you define the master model, you can use the upstream and downstream benefits of Mastertrim, including enabling concurrent engineering, early cost feedback, quicker and more reliable changes, styling criteria verification and reducing design iterations.

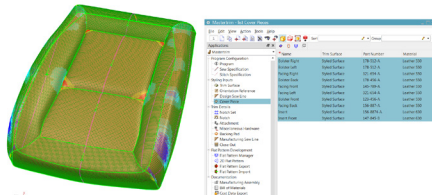

NX Aerospace Design*

Includes a set of tools (aero step, aero rib, aero shelf and aero flange) specifically tailored for designing aerospace parts. This module also includes NX Advanced Sheet Metal tools for creating non-straight brake formed parts.

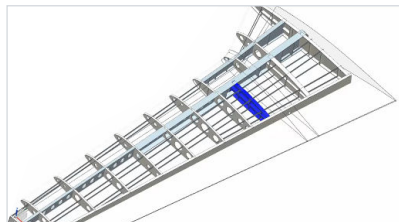

NX Ship Structure Basic Design*

Quickly model a preliminary macro view of the ship based on inputs available from the concept design stage. Also, easily model and modify a structural macro view of the ship to support early design stage analysis, drawing generation and the transition to detail design. The basic design model includes hull, plate and profile systems that they can further split with seams into smaller subsystems. Define decks, bulkheads, pillars, stiffeners and edge reinforcements. Additionally, add standard parts, brackets and cutouts to the basic design model. The resulting models can be used in gross material estimates and weight and center of gravity calculations. The basic model transitions seamlessly to a detailed design.

NX Ship Structure Detail Design*

Define and modify a ship's structural detail parts. This module includes tools for parametric detail feature definition for quickly placing and modifying plates, stiffeners, brackets, holes, profile cut-outs, clips and collars, chamfers, end cuts, corner features, edge features and flanged plates.

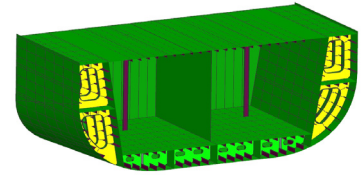

Additionally, create structural pillars and apply insulation material to steel surfaces. All data generated from this application can be used for manufacturing and production planning outputs.

NX Ship Structure PMI Creation

With this add-on to NX Ship Structures Detailed Design, create PMI views with similar dimensions and annotations to those created by combining NX Ship Drafting and NX Ship Structure Dimensioning and Advanced Annotations.

NX Ship Structure Manufacturing Preparation*

Create data for structural part fabrication and generate manufacturing parts from the detailed design parts within a manufacturable unit and restructure it to organize parts and enable welds distribution within the manufacturing assembly structure.

NX Ship Manufacturing Super Plate*

Combine two or more planar manufacturing plate parts to form a Super Plate part using the NX Ship Manufacturing Super Plate software. Additionally, it copies all manufacturing processes that already run on the individual plate parts, like the cutting side face, reference line, excess material, weld information, etc., to the Super Plate.

NX Ship Drafting*

Create the necessary drawings for classification approval. Additionally, create frame bars on drawing views along with ship-building-specific baseline dimensioning methods. Also, automatically annotate ship section drawing views to include stiffener section symbols, structure identification symbols, filling line representations, scantling information and continuity symbols. Add annotations to each ship structure object and control the color, fonts and widths of the ship's structure lines.



*Token licensing available

NX Ship General Arrangement Design*

Create quick and accurate proposals for new ships based on customer requirements during the concept design phase. Leverage tools for creating a 3D model of the general arrangement of a ship and its corresponding 2D drawings. This includes the capability to initialize the general arrangement design process based on a configurable product structure, along with defining the concept grid model and the deck-based breakdown of the ship. Detail each deck into room spaces based on a specific purpose. Also, calculate the net and gross volume and surface area for each space. Additionally, add standard equipment, parts and accommodation-related items from the reuse library to these spaces.

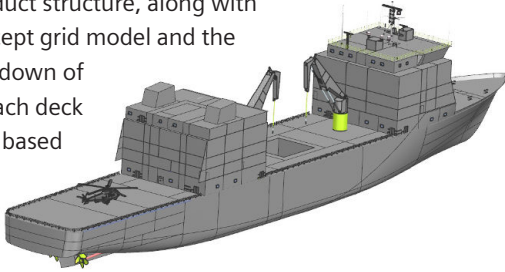

NX Issue Management

This includes an interface inside NX for integrating directly with Teamcenter issue management capabilities. Directly create, edit and manage issues, as well as associate 2D images and other files with issues.

NX Rules-based Structure Welding*

Automatically define welds in the 3D model and generate a lightweight object to represent each weld joint. This enables you to define and work with large quantities of welds in NX. The software creates weld joints automatically based on the 3D part geometry and material, including the placement and bevel configuration. This application supports varying bevels, 3D edge preparations, automated product manufacturing information and drawing weld symbols.

NX for BIM*

Quickly create buildings in a collaborative design environment with NX for BIM software. This module includes a library of BIM objects and features for working with a building structure, grids and elevation lines, roofs and BIM object classifications.

NX for Concrete Design*

Quickly create reinforced concrete design elements with crossing and longitudinal rebars by leveraging NX for Concrete Design software, which is an advanced 3D parametric design tool.

Part manufacturing

NX Staged Models*

Streamline the overall staged model design process for production planning and author complete manufacturing information within the 3D staged models with the NX Staged Models software. This includes a geometric representation of staged, PMI and other manufacturing process information.

NX Process Planner*

Enable a model-based part manufacturing process that is directly connected to design data with NX Process Planner software. With this module, you can extract and consume all contents from 3D models with model-driven and associative process definitions for part manufacturing. Easily assign and view contents needed for operations, such as staged models, stocks, tools, resources, roles and materials. Then, you can export bill-of-process (BOP) contents for downstream enterprise resource planning (ERP) or manufacturing execution system (MES) consumption.

NX Process Modeler*

Define, validate and optimize process operations, datums and tolerances with NX Process Modeler software, a model-based alternative to the 1D/2D spreadsheet tolerance stack-up for part manufacturing. Predict part quality, process capability, key process characteristics and criticalities. With this module, you can confirm that the part manufacturing process meets design requirements through upfront tolerance validation.

NX Process Instructor*

Author and publish work instructions based on the BOP with all contents needed for downstream consumption. This module is powered by live document technology, where the documentation is always live and up-to-date, showing models, attributes, images and more. You can publish the documentation in the NX Technical Data Package module.

Automation

Mechatronic design

Break down barriers between electrical, mechanical and automation engineers with a multidisciplinary approach to machine design. With a library of joints, motors, sensors and actuators, along with kinematic and dynamic properties for each component in NX, rapidly perform a physics-based, interactive simulation to verify machine operation.



NX Mechatronics Concept Designer*

Build concept models that combine mechanical, electrical and software components based on system-level product requirements. This enables early conceptual design capabilities in the mechanical, electrical and automation design and engineering disciplines and their associated parallel interdisciplinary workflows, supporting a coarse to fine product development process.

NX MCD Player*

This is a read-only viewer and simulation player for models created with NX Mechatronics Concept Designer (MCD) software. Load and play mechatronic machine simulations. Additional signal mapping capabilities are available to drive simulations using programmable logic controller (PLC) hardware or virtual software simulations of a PLC.

Factory design

With NX, you can quickly design and visualize production line layouts and associate them with manufacturing planning. Easily optimize the process by specifying each production step down to managing a single manufacturing resource, such as a robot or fixture. Perform accurate impact analysis and drive efficient change management by using a library of parametric resources.

NX Line Designer

This powerful manufacturing layout solution is integrated with Teamcenter fourth-generation design (4GD) or manufacturing process planning. This includes a rich library of parametric equipment, like racks, conveyors, safety equipment and material handling equipment, that you can use with Teamcenter Classification.

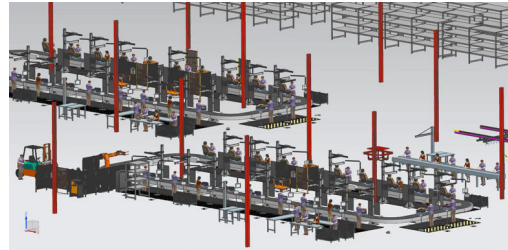

NX design products key add-ons overview

(Content is subject to change)

Core	Token licensing		
NX Translator for STEP AP242	Yes	NX Reference Point Cloud View	—
NX Translator for CATIA V4	Yes	NX Join	Yes
NX Translator for CATIA V5	Yes	NX OmniFree Transformer	—
NX Translator for Creo	Yes	NX OmniMesh Transformer	—
NX Translator for ACIS	Yes	NX Advanced Convergent Modeling	Yes
NX Translator for IFC	Yes	NX Implicit Modeling	Yes
NX Translator for Rhino	Yes	NX Advanced Assemblies	Yes
NX Translator for 3DXML	Yes	NX Design for Additive Manufacturing	Yes
NX Translator for Revit	Yes	NX Composites	Yes
NX Translator for G3D	Yes	NX Composites Laser Projection Interface	Yes
NX Command Prediction	Yes	NX Composites CAE Interface	Yes
NX Smart Selection	—	NX Sustainability Impact Analysis	Yes
NX Select Similar Faces	Yes	NX Lattice Designer	Yes
NX Voice – Command Assistant	Yes	NX Author for ECLASS	Yes
NX Viewer	Yes	Model-based definition	
NX DMU and Markup	Yes	NX Product and Manufacturing Information	Yes
NX DMU and Markup Add-on for NX Viewer	Yes	NX Model Based Definition	Yes
NX Extended Reality	Yes	NX PMI Effectivity	Yes
NX Appearance Management	Yes	NX Technical Data Package	—
NX Appearance Management for Managed User	Yes	NX Coatings	Yes
NX Multi-User Design Notification	Yes	NX Inspector	—
NX Smart Context Designer	Yes	Knowledge reuse	
NX Immersive Explorer	Yes	NX Algorithmic Modeling	Yes
NX Immersive Designer	Yes	NX Product Template Studio Author	Yes
NX Copilot	Yes	NX Product Template Studio Consumer	Yes
		NX Open Toolkits Author	—
Mechanical		NX Open for .NET Author	—
Industrial design and styling		NX Open Python Author	—
NX Render	Yes	NX Open Dialog Designers	—
NX Realize Shape	Yes	NX Open GRIP Author	—
NX Draw Shape	Yes	NX Integration to Geolus	Yes
Product design		NX Integration Classification	Yes
NX Show/Hide Similar	—	Design validation	
NX Layout	—	NX Human Modeling	Yes
NX WAVE Control	Yes	NX Human Modeling Posture Prediction	Yes
NX Assembly Path Planning	Yes	NX Design Simulation	Yes
NX Lattice Structures Design	—	NX Motion	Yes
NX Structure Designer	Yes	NX Animation Designer	Yes
NX Platform Design	Yes	Simcenter FLOEFD for NX	—
NX Topology Optimizer	Yes	NX EasyFill Analysis	—
NX Design Space Explorer	Yes	NX EasyFill Analysis – Advanced	—
NX Performance Predictor	Yes	NX Check-Mate Runtime	Yes
NX Advanced Sheet Metal	Yes	NX Check-Mate Author	Yes
NX Fabric Flattener	Yes	NX VDA 4955 Checker	Yes
NX Weld Assistant	Yes	NX HD3D Visual Reporting	Yes
NX Physical Architecture Diagram Author	Yes	NX One-Step Formability Analysis	Yes
NX Physical Architecture Diagram Viewer	Yes	NX Mold Cooling	—
NX Physical Parameter Management Author	Yes	NX Forming	—
NX Physical Parameter Management Viewer	Yes	NX Forming SMP	—

NX Corrosion Analysis	—
NX DFM Advisor	Yes
NX CFD Designer	Yes
Routed systems	
NX Diagramming	Yes
NX Routing Base	Yes
NX Routing Piping and Tubing	Yes
NX Routing HVAC	Yes
NX Piping Fabrication Drawings and PMI	—
NX Penetration Management	Yes
Electrical	
Electrical systems	
NX Routing Cabling	Yes
NX Cable Router	Yes
NX Routing Harness	Yes
PCB systems	
NX PCB Exchange	—
NX PCB Exchange for Xpedition	—
NX PCB Exchange for Zuken	—
NX Flexible PCB	Yes
Process	
Jig, fixture, tooling	
NX Mold Wizard	Yes
NX Molded Part Designer	Yes
NX Feature2Cost – Stamping	—
NX Feature2Cost – Mold	—
NX Flow Blend	—
NX Electrode Design	Yes
NX Progressive Die Wizard	Yes
NX Die Structure Design	Yes
NX Die Engineering	Yes
NX Molded Part Validation	Yes
NX Conformal Cooling Channel Design	Yes
NX Tooling Locators	Yes

Industry-specific applications	
NX General Packaging	Yes
NX Vehicle Design and Validation	—
NX Vehicle Design Advanced Validation	—
Fibersim	Yes
Mastertrim	Yes
NX Aerospace Design	Yes
NX Ship Structure Basic Design	Yes
NX Ship Structure Detail Design	Yes
NX Ship Structure PMI Creation	—
NX Ship Structure Manufacturing Preparation	Yes
NX Ship Manufacturing Super Plate	Yes
NX Ship Drafting	Yes
NX Ship General Arrangement Design	Yes
NX Issue Management	—
NX Rules-Based Structure Welding	Yes
NX for BIM	Yes
NX for Concrete Design	Yes
Part manufacturing	
NX Staged Models	Yes
NX Process Planner	Yes
NX Process Modeler	Yes
NX Process Instructor	Yes
Automation	
Mechatronic design	
NX Mechatronics Concept Designer	Yes
NX MCD Player	Yes
Factory design	
NX Line Designer	—

Siemens Digital Industries Software
siemens.com/software

Americas
 1 800 498 5351

Europe
 00 800 70002222

Asia-Pacific
 001 800 03061910

For additional numbers, click [here](#).

© 2025 Siemens. A list of relevant Siemens trademarks can be found [here](#). Other trademarks belong to their respective owners.